

The Nineteenth lecture

'Ordine Robotico'.



The most patent quality of the Sixth Order is its physique.

It has a big and beautiful body.

"Now this", as the Walrus might have said to the Carpenter, "was strange", because, like T.S.Eliot's "Hollow Men", Modern buildings had not had 'beautiful bodies' since the 1939-'45 war. First they had lost their ornamental clothing, then, like the figures of Giacometti, they had lost their softly sculptural flesh, until, like dessicated insects, half way to fossilisation, all that was left was skeleton, exo-skeleton, or 'cladding', with some tubes and nerves in between.

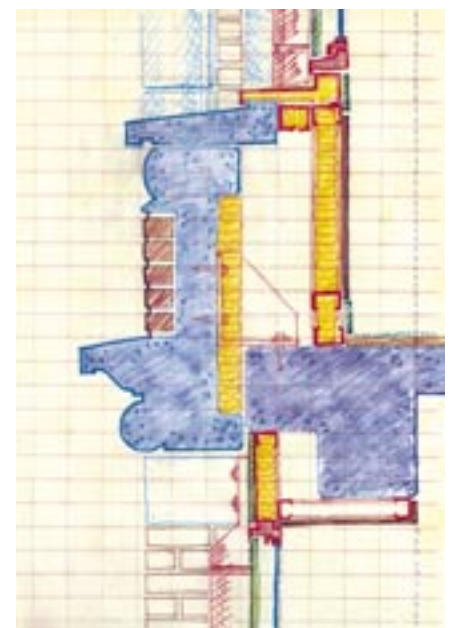
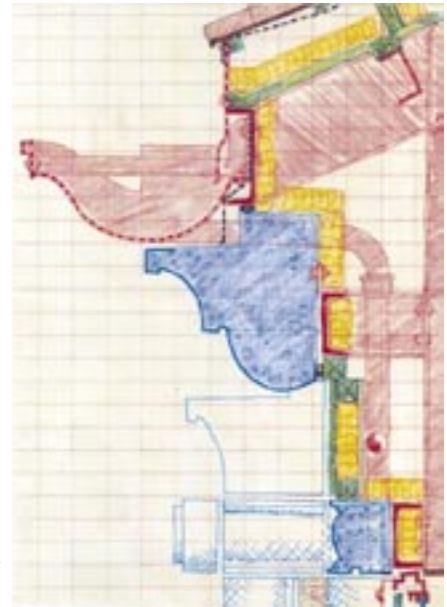

The "construction philosophy" of a JOA building is hand-drawn, by JO, in colour-coded Sections

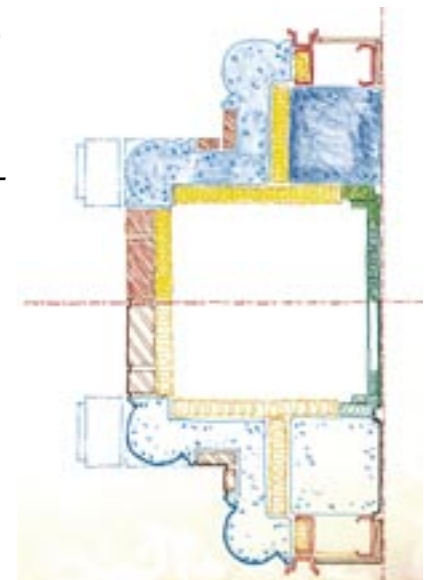

The Plan through the Section above shows the hollow centre to a "Service-Order" column.

Late 20C Building

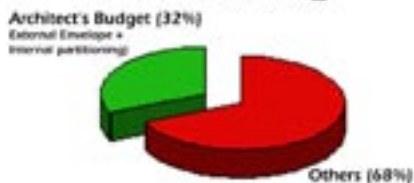

JOA Building

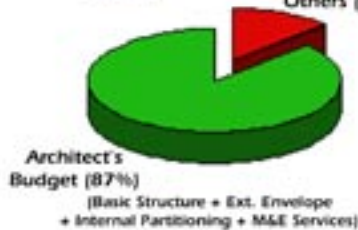

I described in Lecture 9, 'What Taboo', how this sad 'loss of body' had resulted from technical developments during the 20C which had also removed the Architect, or chief body-trainer, from his traditional overlordship of the lifestace-design professions. Then I went on to describe JOA's perpetration of what Professor Robert Maxwell later described as "an act of pure Architectural terrorism: the invention of a Sixth Order". I showed how this returned both the 'body' to building, and the leadership of its processes of design to the Arche - or leading - tekton.

But not only was this supported by an Architectural culture that diverged radically from that of my contemporaries, it diverged from their operational strategies as well. As the critic Peter Buchanan said at my 1986 lecture to the Royal Institute of British Architects:

JOA's invention of the '6th Order' solution, by 'recovering' the Engineers, has the effect of placing even more of the building budget under the Archi-tect's pencil than during the 19C.

"JOA were, to his knowledge, the only consultancy who were enlarging their responsibility for detailed technical design".

Buchanan observed that the general rule was for Architects to shed this role, passing it operationally 'downstream' to highly capitalised manufacturers of patent building systems. Instead of this, JOA went upstream, finding manufactories, large and small, that cut, cast and moulded what JOA drew and specified. By 1992, when the Judge began to build, JOA had 20 years of single-minded pursuit of our 'architectural project'. We chose to build in Pre-cast concrete, timber, folded metal, brick, stucco, cast glass and cast plaster. All of these techniques are 'Low Tech'. Workshop tools need less capital. All of them can take a variety of colours and patterned finishes. All of them are tried and trusted, cost effective, materials.

I did this also because it was possible for an Architect to learn how all these materials and processes should be used. When this mastery was assured, a building could be designed that was 'Iconically-Engineered', through and through, with an Architectural culture of a depth and sophistication that was entirely beyond the purveyors of the patent metal and glass systems, and the proudly illiterate Architects who supported their use. The way I ensured the design was technically competent, was to stop the design process at the moment when it had been passed by the Client Bodies, acquired its detailed budgetary breakdown, and was as certain as anything is to acquire its statutory permissions. At this stage the design would be at 1:200 scale, with elevations at 1:50 and some, but not many, large-scale details.

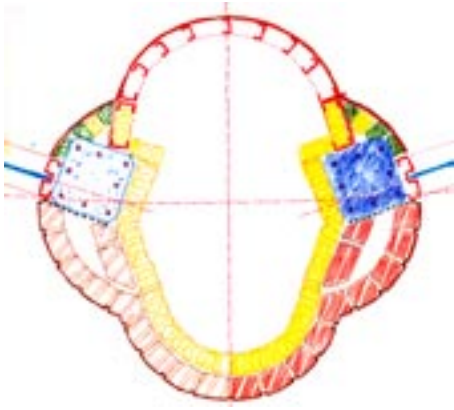

3 Plans, at different levels, through the hollow columns of the Den Haag Groenmarkt Rotunda. Bricks flow pliantly around concrete 'props' to create ducts for pipes and wires.

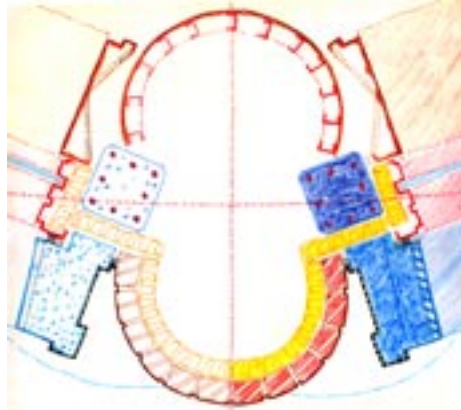

The plan above the capitals of the 'minor order', that brackets the taller shafts of the 'major order', shows the arches in concrete, outside, and plaster inside.

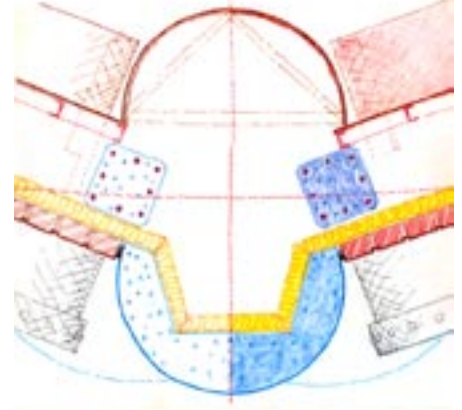

The plan through the concrete external, and the plaster internal, capitals of the tall columns of the "major order" shows the "service space" extending all the way up.

At this stage the design would be at **1:200 scale**, with **elevations at 1:50** and some, but not many, large-scale details. I then went, personally, over the **entire building fabric**. I hand-drew its **'details'**, both generic and specific, at **1:5 scale**. I made these very quickly using a set of **Parisian fountain pens**, called 'Recife', that had clear plastic barrels through which the **coloured ink** could be seen. These pens lasted for 12 hours without refuelling - or a whole inter-continental flight. Each colour denoted a different material - **metal, insulation, brick, concrete, wood, glass, stone** and so on.

I drew on sheets pre-printed with the three-dimensional module of the **English Brick**. In this way I never needed to 'dimension' anything. The advantage of the colour was that the **freehand lines**, although wobbly, could **touch and overdraw each other** without the 'reader' ever **confusing** them. These **A3 drawings** were then **'layered-up'** on sheets of **clear acetate** on which the **grid was printed** and **verbal comments noted**. They were then either **scanned-in and e-mailed**, or simply **printed on our big Canon copier** before being physically **mailed to all the design team collaborators** - wherever they might be on the globe.

By these means the **design acquired its 'constructive constitution'**. It made **constructionally patent**, to the whole diversity of the **many hundreds of person** who put a building together, **in constructive**, rather than pictorial detail, **how the fabric would be built**, from **inside to outside**, with as few 'grey' areas as possible. It was then up to the teams to **make this 'construction philosophy' work in all the necessary ways**. All the diverse specialities knew the **detailed dimensional, assembly and material-deployment 'rules'** within which their separate problem-solving and procurement tactics must operate. This was how **JOA were able to actually construct projects** that were **saturated with the 'Architecture'** that **Mainstream Modernism had tabooed** yet satisfy all of the **'real world' constructive, material, legal and financial imperatives**. It was this ability to **'Iconically Re-Engineer'** an industry rendered illiterate by its biggest Clients that had **taken JOA to the top**.

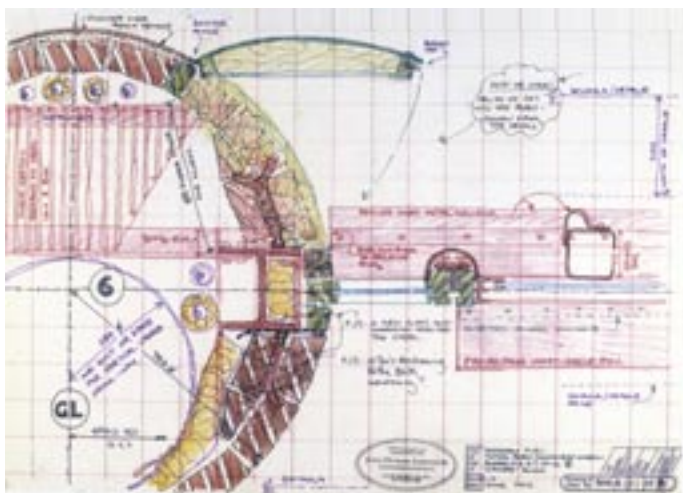

JOA's original "construction philosophy" sketch-plan through the 1500 mm dia. columns of the Judge Institute shows a horizontal access walkway passing through the 'service columns' from side to side. This was simplified to a vertical access cat ladder up some of the columns. It gave access to the "Service Entablature" from which were hung moveable gondolas for servicing and cleaning the high glass walls with the metal 'light-shelves' that shaded the interior from direct sun while reflecting daylight up onto the decorated ceiling.

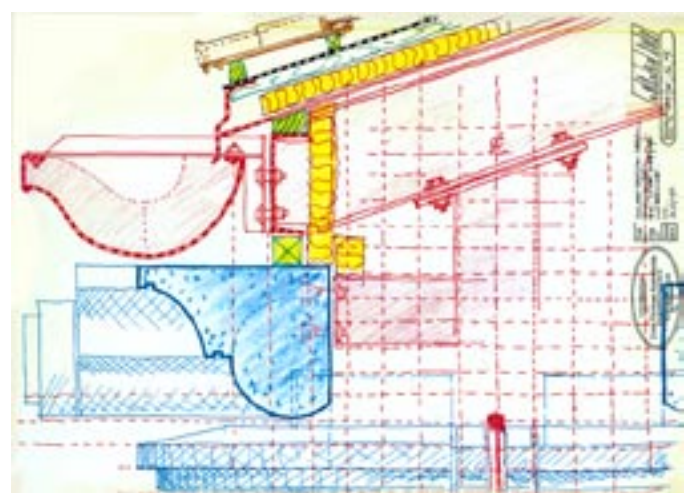

Metal is red, Concrete blue (pre-cast is pale, in-situ dark), insulation is yellow, dpc's are black, wood is green, brick and tile are brown. The freehand ink lines overlap but, being of different colours, are not confused. No dimensionis are needed as JOA buildings 'snap' to a vertical and horizontal brick grid. The brick is a handhand-laid thing that 'humanises' the scale of everything. The final structure matches this sketch almost exactly.

The project for the **Judge Business School** had four new blocks. They were ALL designed upon an **hypostylar module of 1.5M (5'0")**. Yet this **uniformity, instead of erasing** the differences between them, served to **distinguish** one block from another. This happened because of the novel amplitude of the **Sixth Order**. **Half-way between a wall and a column**, it is the **sheer bigness** of the **6th Order** that enables the Architect to **manipulate** it into a **large variety of plan shapes** all of which can use a **variety of inexpensive materials**.

The **'Ark'** was the smallest of the four buildings that went to **compose the totality of the Judge**. It had an order that could be perceived as a **column** by its **base and capital**. But the shaft of the **'Ark's 'Order'** **melted back** into the surface of the wall.

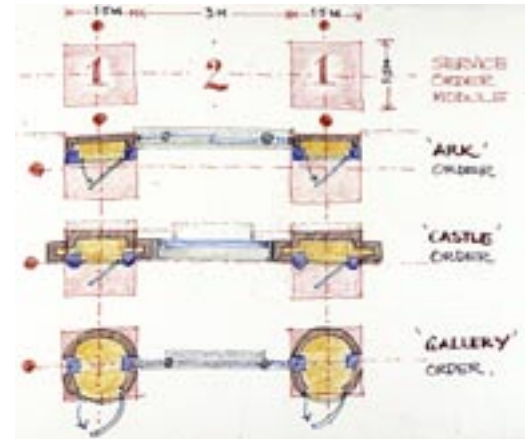

A 1:2 Module unites the four buildings. See Plan to the right for their location.



The interior of the **'Ark'** building absorbs the concrete pillars and **'bressumers'** into the folded walls and ceilings of the **'Working order'**.



The hollow entablature of the Working order conducts horizontal M & E services between the pairs of concrete **'bressumers'** that rest on the paired pillars.



Two 300mm (1'0") sq concrete pillars and a 900mm (3'0") wide duct make up the 1.5M x 1.5M (5 ft. sq) body of the Working Order Column.

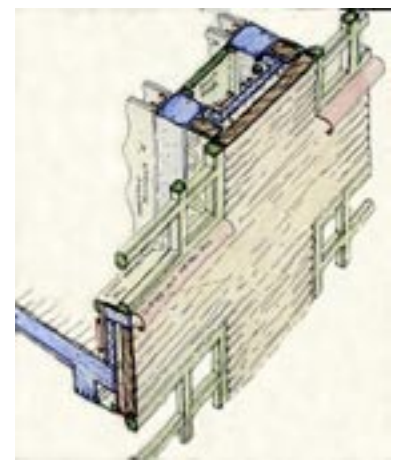

The concrete pillars were set well inside the brick wall, giving a solid, sound-proof, seating for internal partitions. The lateral services ran out along the walls in **'dado-ducts'**.

No one had been able to invent a way of relating a **new building** to the **6.43M (19'6")** floor to floor height of the **19C "Florence Nightingale" Ward Block**. It fell to **JOA** to **vertically compress two floors** of the new **'Ark'** building to **level with the 19C rooms**. This was no strain because the **6th Order** puts the mechanical services into the walls and columns. This allows the ceiling, and even the floor, to **serve as 'scripted surfaces'**. One may **inscribe** them and be sure that they will not be demolished to replace some **perishable pipe or wire**.

We used the **coloured-brick 'Iconic Engineering' script-patterns** of the external wall to **unify the plane** of the wall into a single sheet. This **obscures the problem** of articulating plastically- exiguous columns against equally undemonstrative spandrels.

The **Sixth Order** separates the components of the **Architectural Order** from the physical **'services'** that the Order **disciplines to the rituals of the Architectural process**. The **verticals** and **horizontals** of the **Order** are known as its **column, beam, floor and ceiling** while those of the **physiological services (nomally called 'the structure')**, are known by the newer, **Engineering, terminology of prop or pillar, bressumer and slab**.



The Ark block had to be compressed vertically to also allow light to its neighbour across a narrow alley. This also lets Eastern side-light into the Gallery, which warms it in the winter. Light-shelves up this wall prevent summer heating.

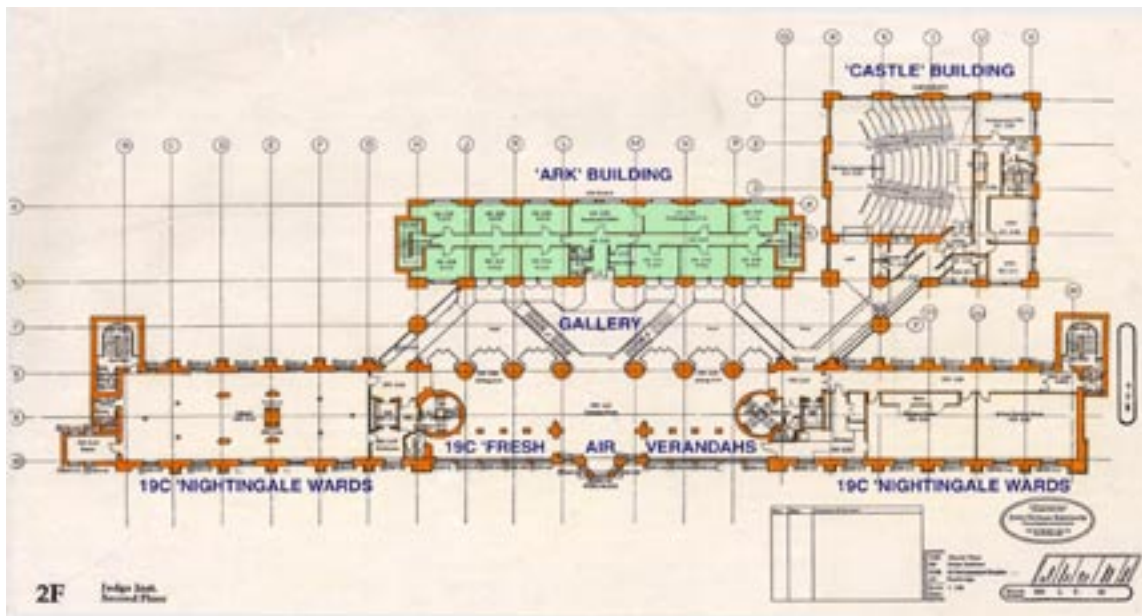

The Judge works as a single building but looks like three new ones plus a very long, 19C, one. All four share the same, 1:2 'classic' intercolumniation 'Module'. Each building is clearly itself yet part of a 'whole that is greater than the parts from which it is composed'. A detail, is that the gap, at the centre of the even succession of column centre-to-centre dimensions was 'closed' by the invention of the 'double-bubble' columns that can be seen third and fourth from the right in the photograph immediately below. This kept the same 3M (10'0") inter-columniation dimension (or window) carrying across down the whole 50M (162'0") length of the Gallery interior.



The Ark, fronting a narrow alley, lies low down, topped by a primordially 'Attic' roof garden. The iconography of the 'rafted entablature' is extended up from the Ark's flat face into the design of the balustrade. Blue and black glazed bricks (the characteristic colours of Ocean), are inscribed on the wall below a lattice of yellow raft-sticks that 'carry' the red and black 'cones of Hestia' that also double as physical balusters. The blue balustrade repeats, with the cubistic distortions native to 20C iconics, the sea that surrounds the rafted germ. The flowering garden is both the 'promise' brought by the voyaging 'founders' and the elevated arcadia that was left on the tops of the primordial islands at the time of the recession of the Flood and the Fall of Man. The eight black 'planters' were cast as single concrete tanks weighing two tons each.

If the 'Ark' had to **shrink** in order to suit itself to this **tight urban site**, the Castle had to **swell** if it was to perform the role given to it by the site planning strategy, described in Lecture 15: 'The Photolithie' (page 15-2) - which had won JOA the Judge commission. Instead of forcing its Order to retire **behind a flat wall-plane**, it was permitted to the Ark to place its **columns and entablature outside the surfaces of the interior**. This is, as any practical room-planner will admit, **the best place to put them**. **Few people** want their walls interrupted by either **protuding**, or **even worse, free-standing**, columns (in the manner preferred by Corbusier and his followers).



Urbanity = public space. Streets and squares are made by fronting them with facades that speak to human beings. Human beings are not machines that merely go or stop. We appreciate the to and fro of a 'gaming' discourse. As with any game, the rules must be clear, as well as clearly exercised. The faces, all four of them, of the Castle show an Architecturally 'primitive' cubic block. This is sculpturally 'gamed' away, while still adhering strictly to the rules of Architecture. This surgery reveals firstly, a battered blue base that is the khumba/submarine mountain. This contains the 'break-bulk' stores of the adjacent biochemistry faculty. Above the sheen of its oceanic blue engineering bricks there is a platform, with softly billowing edges that carries the columnar superstructure. The column-shafts rest on cubic earth-symbols that also, as in the nearest one, serve to take fresh air, via sound-proofed propellers, into the Judge Auditorium. The big round windows of this large room play against the ordinary square ones of adjacent study-rooms.

The **urbanistic situation** of the Castle required that it **project its communicative discourse** across a **wider field** than the Ark. The Castle had also to accommodate the most complex internal order of rooms. There were **two auditoria** with the **sloping floors** that are so beloved of Functionalists who never fail to 'express' this oddity. They sieze on auditoria (often sloping not only floor but roof) as if to prove that Functionalism is capable of the **novel architectural language** that they have, in 100 years, still failed to establish.

I preferred to use the **legitimate peculiarity** of these **two rooms** (one was **suspended into the ceiling** of the other) to force a 'difficult' game with the **sculpted body** of my **6th Order**. The auditoria were given **circular windows** whose **blinds closed like eyelids**. Below these large **daylight-holes**, which remained **above eye-level**, I made **small square openings** that could be **closed against the view of the exterior** so as to **focus the attention** of the audience.

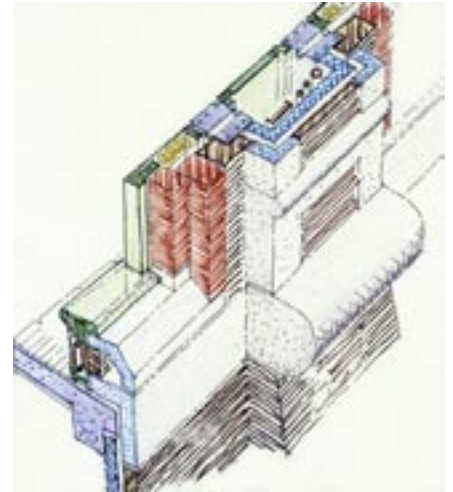

My first sketch of the Castle 'Order' at the transition from the battered blue brick base to the columnar superstructure. The blue brick base swells out to engulf the columnar order which is indicated only by those thin vertical cracks which are now technically necessary to control the tendency of fired earth to swell very slightly over time.

Above the billowing string-course the wall and column play a game of hide and seek that takes full advantage of the amplitude of the 1.5x1.5 M (5'0") columnar module of the 6th Order.



The glossy black capitals of the Order represent the 5th ontogenic stage of ideation. The wall over the uppermost windows is of wood painted a recessive green. This signals that the Entablature rests on columns, and not walls.



This building was given its name because its battered base contained rooms that needed fresh air and no large windows, in short a sort of dungeon, in this case containing combustible stores for, and refuse from, the large biochemistry campus nearby. The two lower storeys, cased in 'battered' (a technical term meaning sloping) blue brick are a memory, entombed in masonry, of the 'cricket pavilion' proposed by the normatively suburban planning culture of the University Grounds department. This skin is, as it always is in our buildings, only 10cm (4") thick. Keeping it sloping requires the Architect to perform the chore of calculating the special bricks needed to turn the corners, of which there are plenty in its beautifully sculpted body. Making the few 'ordinary' windows into this massive corpus resulted in peculiarly deep reveals (technical term meaning sides to an opening). It was essential that these were white, in order to reflect light into the room- a lesson that can be learned by the way the 18C painted openings in their brick facades. I achieved this whiteness with fat white 'art stone' cheeks like gun ports.

The window sills are black partly because they always get dirty and partly because a window framed by columns and a beam is always more 'noble' than one which is a mere Saxon wind-hole punched into its imprisoning wall. Laugier taught me that the columnar building was for the free citizen, governed by law, whereas the mural structure was for serfs governed by force majeure.

Whereas in the Ark, the Entablature had to flatten upwards into the design of the balustrade, here, in the Castle it could spread outwards physically in the way that its Column-shaft does. In this it does not distinguish its Order from that used on the Gallery which appears above and behind it. However this 'Castle-Raft' does not cease to crown the 'Mountain' of the Castle as it enters the interior of the Gallery. It continues round it completely, the same inside as out (in the 'English manner?'), It reifies the icon of the 'Rafted Pyra' with its ash-cone profile of "that which comes from afar". Only, in this case, the cargo is a blue-green "Mountain of the Sea".



Cambridge appears to be an ancient Gothic pile only because Britain, in the ethological response to 18C Revolution banned everything Greek, Roman and French from its institutions of religion, education and philanthropy. Downing is the only vision of what the university city would have looked like without the Victorian imposition of pseudo-Mediaeval Neo-Feudalism. Quinlan Terry's, keeping in keeping, neo-Neo-Classical library houses a late 20C carbon "Buckyball" molecule in its metope. At least it offers the teenage undergraduate a taste, albeit a-lexicalised by its avoidance of polychrome, of the lifespace-engineering of Mediterranean Republicanism.

The 'occluded temple' of the Judge Institute, largely invisible from close to, unsheaths its giant columns to the eye as it looms over the chaste pallor of this Nordic Athens. The Judge is best seen in the late afternoon when the low sun cuts through the Judge Gallery to show the gigantic 'raft' of its entabled roof as really flying/landing/taking-off over its forest of columns.

The 'body' of this 'Gallery' is that of the most highly-regarded of all buildings.

It is a **free-standing 'temple'** of **detached columns**. This form, in the physical role of a **'lantern-core'**, was introduced on Lecture Three page 3-3 in a discussion on **sunlight**. But what justification could there be, in 1990's Cambridge, for any **faculty-building** to assume the **form of a temple**? It is a symptom, of the late 20C 'consumerism' of public squalor and private **luxury**, that such a question could even **come to mind**. For the fact is that **cultures with a public dimension** were accustomed to house this sort of space in **Architectural 'temples'** - whether designated as such, or not. Today, as these Lectures argue, Practitioners know little about **'temples'** and even less of **Architecture**.

EVEN HEIDEGGER, AS I SHOW LATER IN LECTURE TWENTY-SIX PAGE 26-5 , JOINS WITH LE CORBUSIER IN THIS CHORUS OF IGNORANCE. ARCHITECTS ARE NOT ALONE!

Perhaps the greater irony is that it was an **Architectural 'Classicism'** which **rescued Technological Futurism**. For it is the **'trabeated corpus'** of the Gallery - its **columns, floors and bridges**, that carry the mechanical **'vitals'** throughout the building. 'Functionalism' had **collapsed long ago**. Jim Stirling's Post-Modernism was the 'star' of the 5th Venice Biennale of 1991. But it was Gehry and Eisenmann who **canonised the collapse into formal Deconstruction** which was to follow. The **gigantic 'new body'** of the Judge's Order rises to manifest the **highest single space in the little country town of Cambridge**. It carries its **free-standing Entablature**, the crown of every **'Classic' Architecture**, upon by far the **largest columns in that city**, if not in the whole island. Yet this **temple**, for why not give it its **proper name**, harbours no chryselephantine image of a goddess



(which, as few recognise, **cost far more** than the temple that sought to attract Athena's residence). The 'temple' is, instead, the **focal lifespaces** of a **New Institution**. It is the **'space of appearances'** by which the Institute's **'citizens'** will become real to each other. It is the **theatre** on which the Institute can not only play out its daily life, but **rehearse those 'monumental' rituals by which it comes into being** as a **having-come-into-existence 'experience'** that is a part of **lived History**. This is the place where my **long-standing, and constantly-thwarted, ambition would be fulfilled**. I would banish, **for ever**, the **'ivory-tower (steel, glass and white) aniconicism'** which the 20C had created for its **'Authentic' Style**. It was this **dissimulation of the lifespaces of power** which had enabled the **public realm** to be so rapidly destroyed after WWII. It had **ignored the fact** that in any politics (**whatever**) it was essential that the **means and ends** of such decisions and judgments be **'reified in 'Urbane flesh'**.

The **Gallery of the Judge** would **reify the idea** that the culture, indeed the **'cult(s) of the future** will be **'built-into' the lifespaces** of the **'Urbane Man'** of the 21C is such a way that, as he **acts** within it, he **understands** its entire **political, economic and cultic 'emplotment'**. The peripheral rooms of the Judge would **recall these discourses** by **'sailing into' this iconised 'Rainforest of Reality'**. What more perfect place to institute this **revolution towards philosophy** than an **'Institute of Management'**?



The vertical extension of the Gallery-building is only visible from far off or in an architectural elevation that makes no allowance for the foreshortening imposed by the perspective of real vision. The rafted roof was elevated above the already high (for Cambridge) bulk of the city hospital. This was to allow natural cross-ventilation through upper-limit circular windows that tilt open like valves in an engine. The planting of the garden on the roof of the Ark would have 'reduced' the apparent height of the Gallery Temple by founding it at the properly primordial level of an 'Attica'. The 4.5M (15'0") column-to-column module of the Nightingale Wards ceases to carry across the central entrance. The new double columns are designed to bridge this 'loose centre' with a regular 3M (10'0") inter-columniation. The vertical extension of the Gallery was required for it to act as a 'lantern', both letting in daylight and advertising itself, and its ceiling, at night.

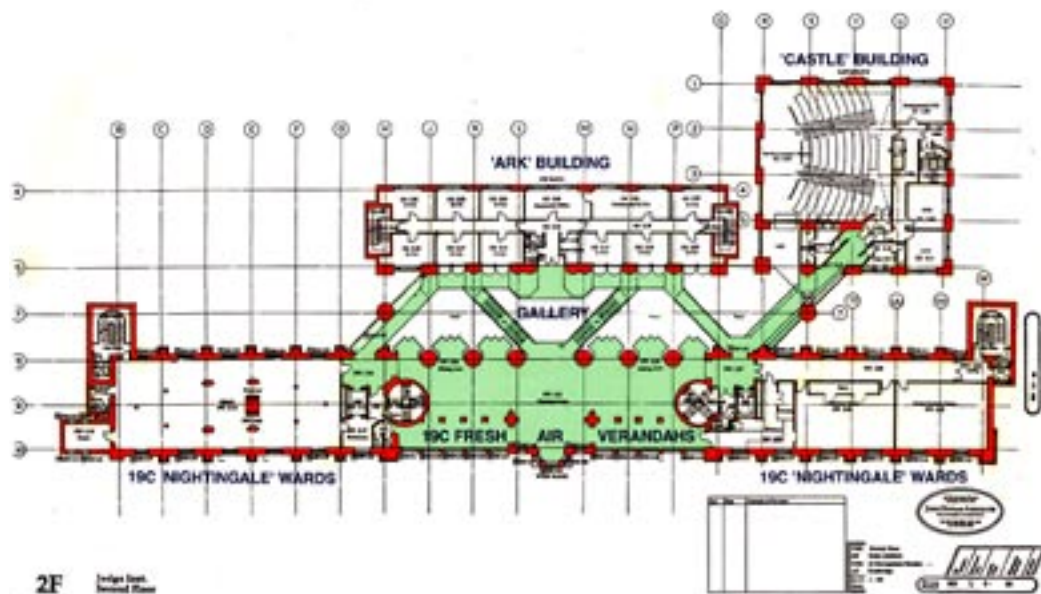

The plan of the Gallery shows how its focal role entails that it is buried behind the other buildings. Once it rises off the ground it becomes, physically, nothing more than the deliberately-labyrinthine web of a central 'social stair' with its bridges that tie the Ark and Gallery to the 19C Hospital. Architecturally, however its emptiness, although exiguous, opens the heart of the Judge to make of it a theatrical 'space of appearances'.

The diagram of the 'Three Orders', on Page 19-4, shows the Order of the Gallery completely filling out its 'modular' footprint'. Firstly; it can 'inflate' because it is not constrained by being pressed up against the property boundary of a tight urban site. Secondly; its hollow shafts have to serve as a 'services core' taking pipes and wires to and from the 'buildings' that abut it. Thirdly; the height of its free-standing columns requires that their width be expanded so as to prove, without any contradiction, that not only is Architecture possible today, but that it can be unequivocally 'modernised'. This 'Giant Order' offers a 'proof' to anyone who 'doubts' the possibility of 'Architecture' now, today, and in the future.

The columns were solidly built using specially-curved cinder-blocks whose radius was guided, on the building-site, by steel hoops to 'found' them on the concrete slab below and 'fix' them to the concrete ceiling above.

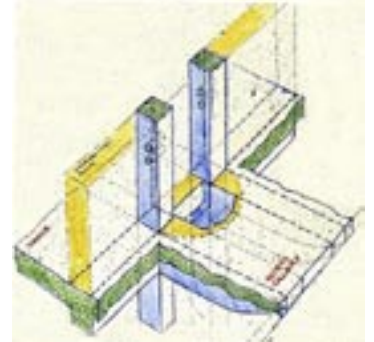
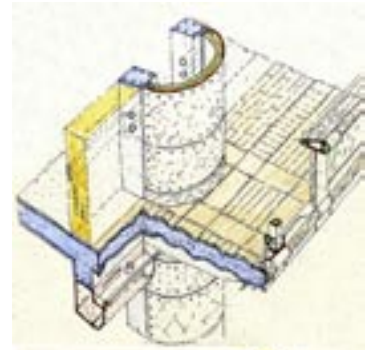

The Gallery column plans pass through many transformations in their vertical height but the vertical pillars of concrete and steel, never more than 30x30cm (12"x12") remain the same.



The bridges that weave across the Gallery carry services between the vertical ducts in the Service Order columns.



A plan through one of the Service Order columns around the Gallery showing the fan and duct from the print room.

The block of the Castle enters the Gallery at its South-Eastern corner. As in the theory of Sebastiano Serlio, the cylindrical shafts of the 'occluded temple' of the Gallery emerge out of the 'cubic' bodies its surrounding, more mundane, structures. The coffers, unfortunately uninscribed, ceiling the idea of the 'doorless rooms' that are the primordial body of Serlio's 'corpo trasparente'.



A steel frame with circular cut-outs held the long-throw ventilation nozzles. The duct doors were also hung from steel frames. Steel performed its usual role of "the whalebone in corsetry". When the carcassing was finished, the curved A3 plaster tiles, and the curved radio-frequency plywood doors were fixed. The original plan was to 'Monoprint' the A3 Tiles before they were adhered.

The decision to inscribe them with decoration, which was always their 'raison d'etre', was postponed for so long that it was not done before the tiles were erected. They could still, even today, be 'monoprinted'.

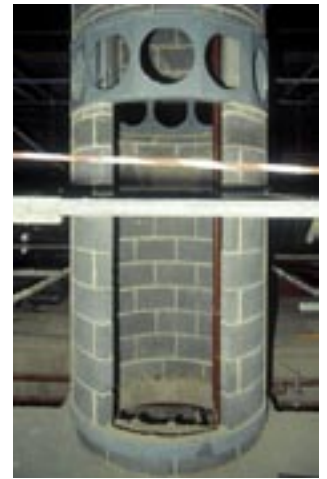

Curved concrete blocks carry the steel ring for the air nozzles.



The feet of the 'necklace core' Gallery columns are connected by a tunnel in which run the drains, pipes and wires that then climb up to each floor.

The 'collars of spikes' are A/C efflux cones that can silently fling outlet air some 30 feet. The single protusion in the top quarter is the ceiling uplighter that extends automatically at dusk.

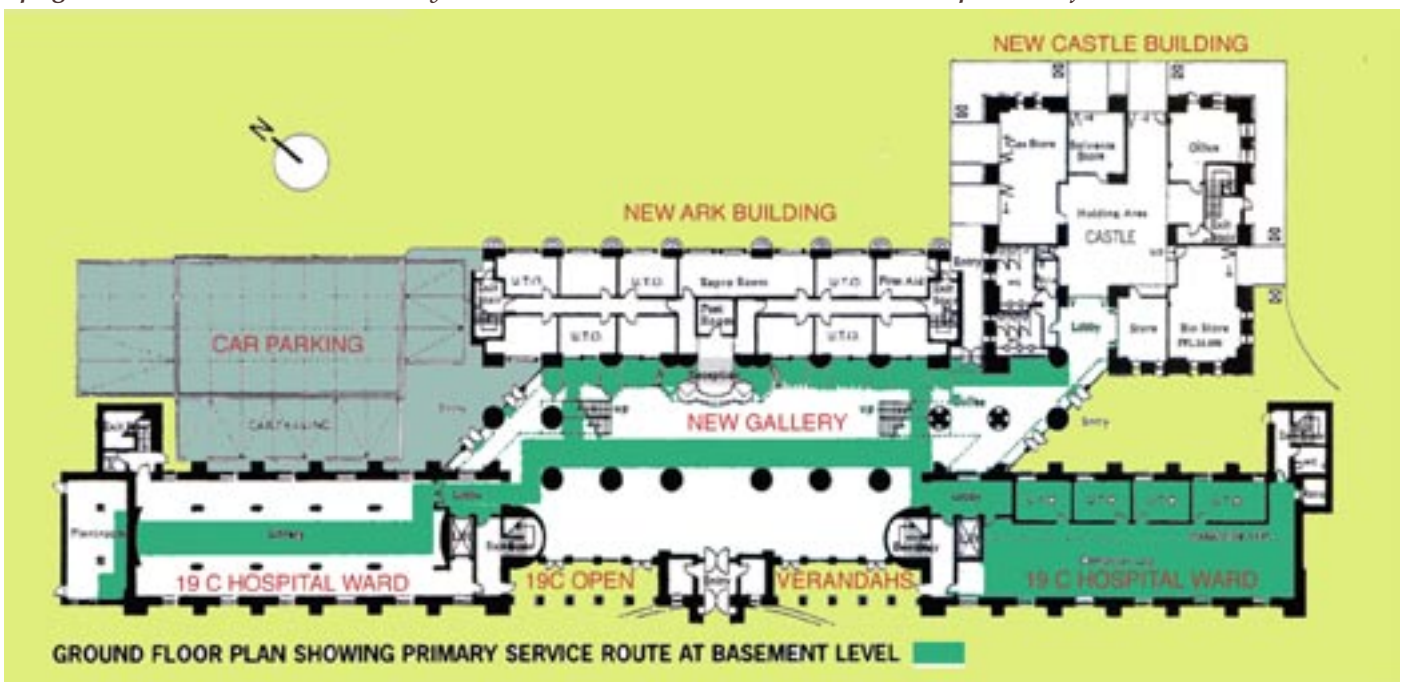

The green 'corridor' is an underground service tunnel that connects the feet of the 'necklace core' of gallery columns, to the surrounding buildings. It is easier to access services if they are on the ground or inside a hollow column large enough to climb inside. This relieves the gallery ceiling, 26M (80'0") off the ground, of any duty to carry services or perform any physical function, such as lighting. The upward-billowing ceiling-vault could be used to 'reveal' the interior of the 'rafted Entablature'. It was free to act as the 'picture plane' for surface-scripted iconic engineering.

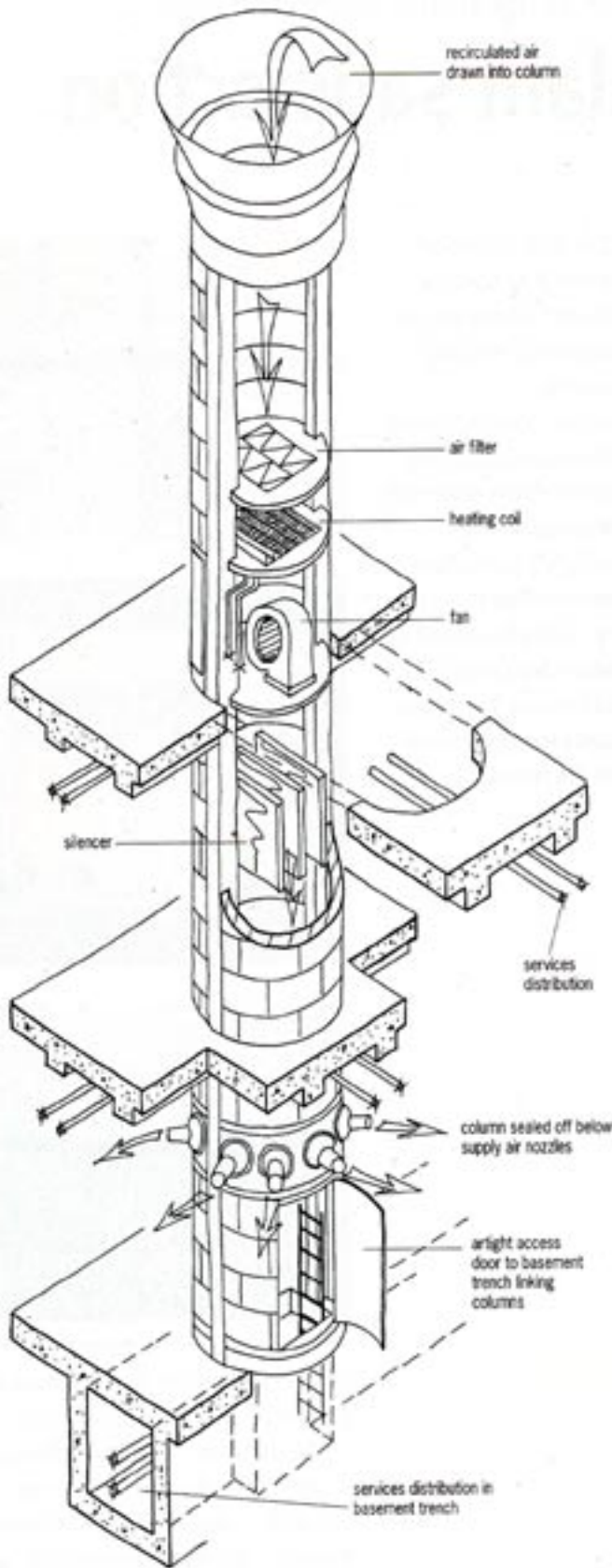

COLUMN CONTAINING MECHANICAL SERVICES

One of the columns containing the equipment that takes internal air at the seventh floor, filters it, warms it if needed and pushes it out, after silencing the fan noise, at the lower levels.

Note the horizontal crawlway duct under the ground floor that connects all the tall columns to each other. This allows for the re-routing of services throughout the life of the building..

Susan Dawson, in the Technical section of the Architect's Journal, writes: "Daylight and natural ventilation are used to minimise the need for services. Thermal mass was used to damp excessive temperature swings. The result was that the building services cost of £154/Msq excluding fit-out is relatively low compared to the usual cost for University arts buildings at £168-£211/Msq."

Dawson continues: "The Gallery is the key to the services strategy - it provides daylight, ventilation and horizontal and vertical services distribution in one volume. The building mass of the Gallery is used to regulate temperature. It absorbs heat during the day and emits it at night. This means that the building can be naturally-ventilated rather than air conditioned. In summer, even during last August's heat wave (1995), its marble floor and exposed concrete ceilings, when combined with the shading by the solid roof and light-shelves ensured that the Galletry was a cool meeting-place".

Dawson continues: "The Gallery is naturally-ventilated by automated opening windows at high and low level. They can remain open at night in hot weather to cool the structure. In winter air-handling units set vertically (as shown to the left), inside four columns recirculate internal air from 24M above the ground down to the user-occupied levels. This evens-out the temperature gradient which, in a tall space, could lead to a suffocating heat up on the seventh floor - (that of the Professor's Study! - J.O.).

Dawson continues: "The Building Management System (BMS) senses rainfall and wind direction so as to mechanically open the 1.8M diameter windows at the top of the Gallery which exhaust air by 'stack effect'. Control is by carbon-dioxide and temperature sensors that balance ventilation against heating."

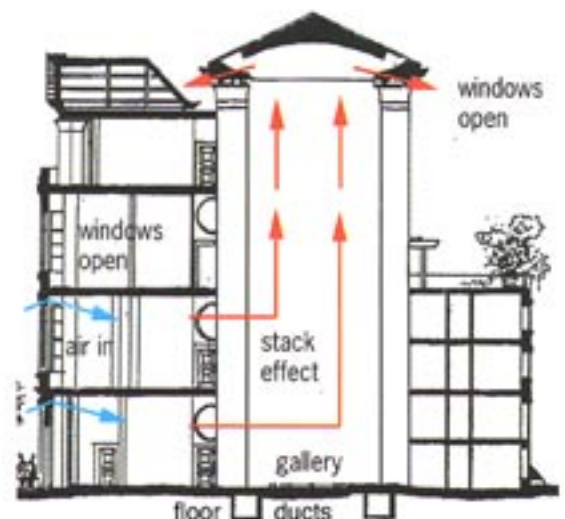

AIRFLOW IN THE GALLERY IN WARM WEATHER

Dawson continues: "Most conventional services distributions have one large vertical riser and many long horizontal ones - like an oak tree with one thick trunk and many long branches. The **Gallery columns** form regular, **closely spaced risers** so that **only short horizontal runs** are needed - the equivalent of a **forest of pine trees** with many **thin trunks** and **short branches**. This offers **easier access for maintenance**, gives greater **flexibility** and does away with the need for **suspended ceilings**".

Dawson continues: "Each column is a **blockwork tube** formed around pairs of **structural pillars** and filled with services: **single and three-phase electricity supply**, **data**, **BMS control**, **telephones**, **heating** and **water supply**, **drainage** and **ventilation air**. The primary service route from the main plant room on the Northern end of the building is via a **deep (existing) duct** past **every column base** that is let into the ground floor. The **horizontal routes**, at each floor, pass between the pairs of **downstand beams** which rest on the **pairs of 24M-high 300x300mm pillars**. Side-hinged **full-height duct doors** on each floor give access to **internal ladders** and **platforms** that reach up to a **crawway** all around the **ceiling**. These enable cables to be lowered between each pair of columns to lift the **gondola** from which to **clean the glass** and **re-paint the high gallery windows**."

Dawson continues: "Finally, the three buildings around the **Gallery**, both **new and renovated**, are treated as **individual fire compartments** with each having their own **protected escape stairs**. The **Gallery** is not classed as an **escape route**. In the **event of a fire**, the high-level circular venting windows would open to clear smoke".

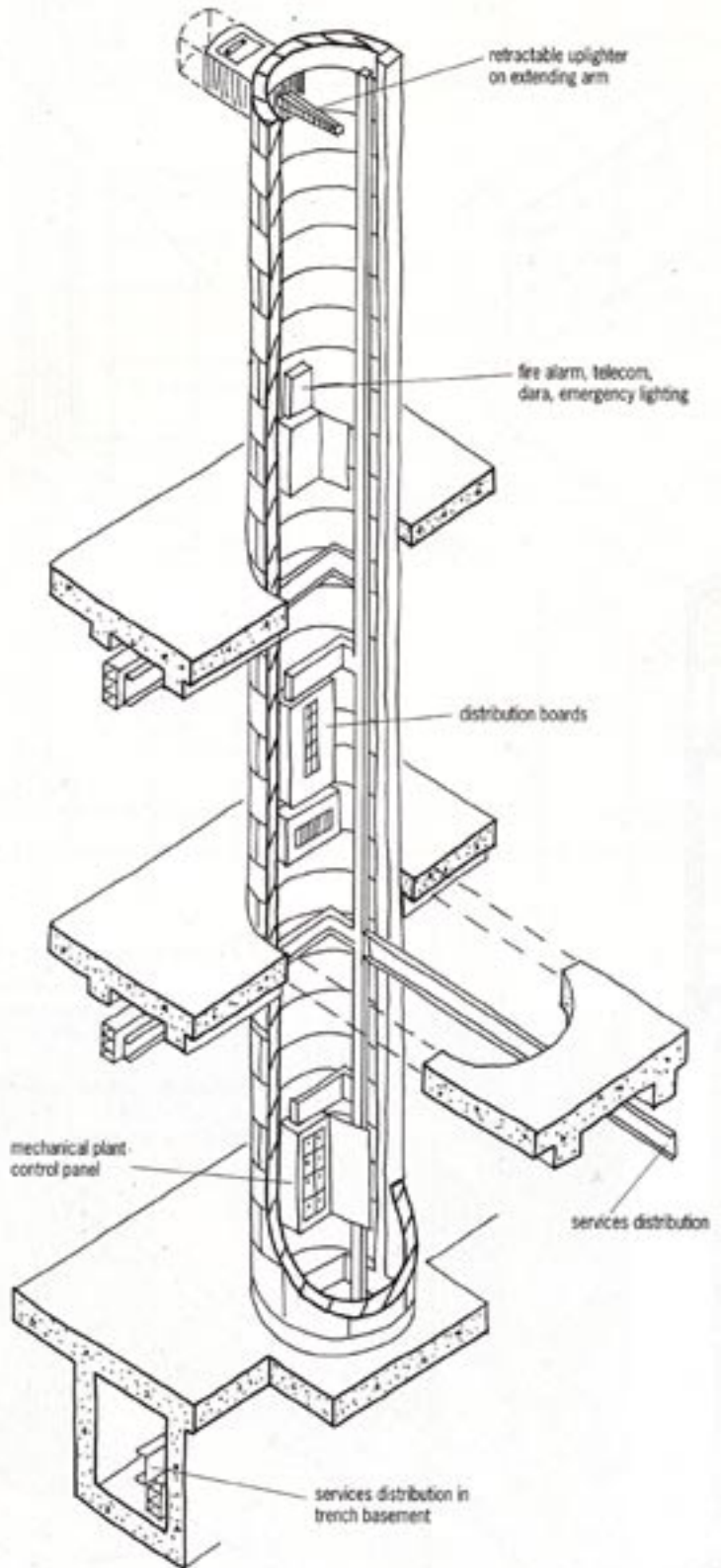

COLUMN CONTAINING ELECTRICAL SERVICES

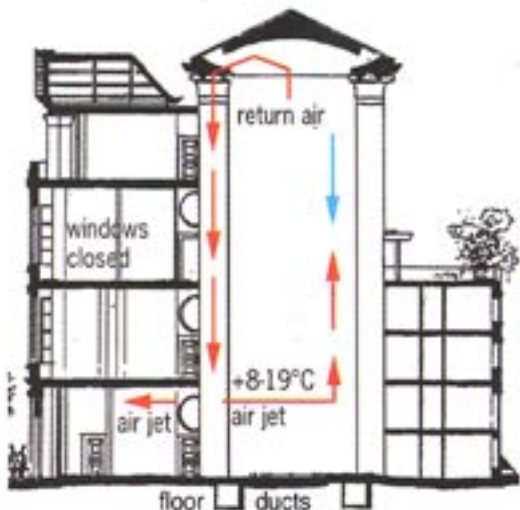

AIRFLOW IN THE GALLERY IN COLD WEATHER

The uppermost unit is an uplighter for the decorated ceiling. It hides behind one of the A3 masonry-tiles. The light slides out, at dusk, on ball-bearing arms of the type used in filing cabinets. It is propelled by an electrically-powered hydraulic piston. On entering the column, a maintenance engineer can climb up and maintain this unit, amongst others, by changing lamps and so on, while standing on an Exmet platform. I have climbed-up them all myself and explored the 'hollow'entablature. A Rite of Passage for 6th Order devotees!

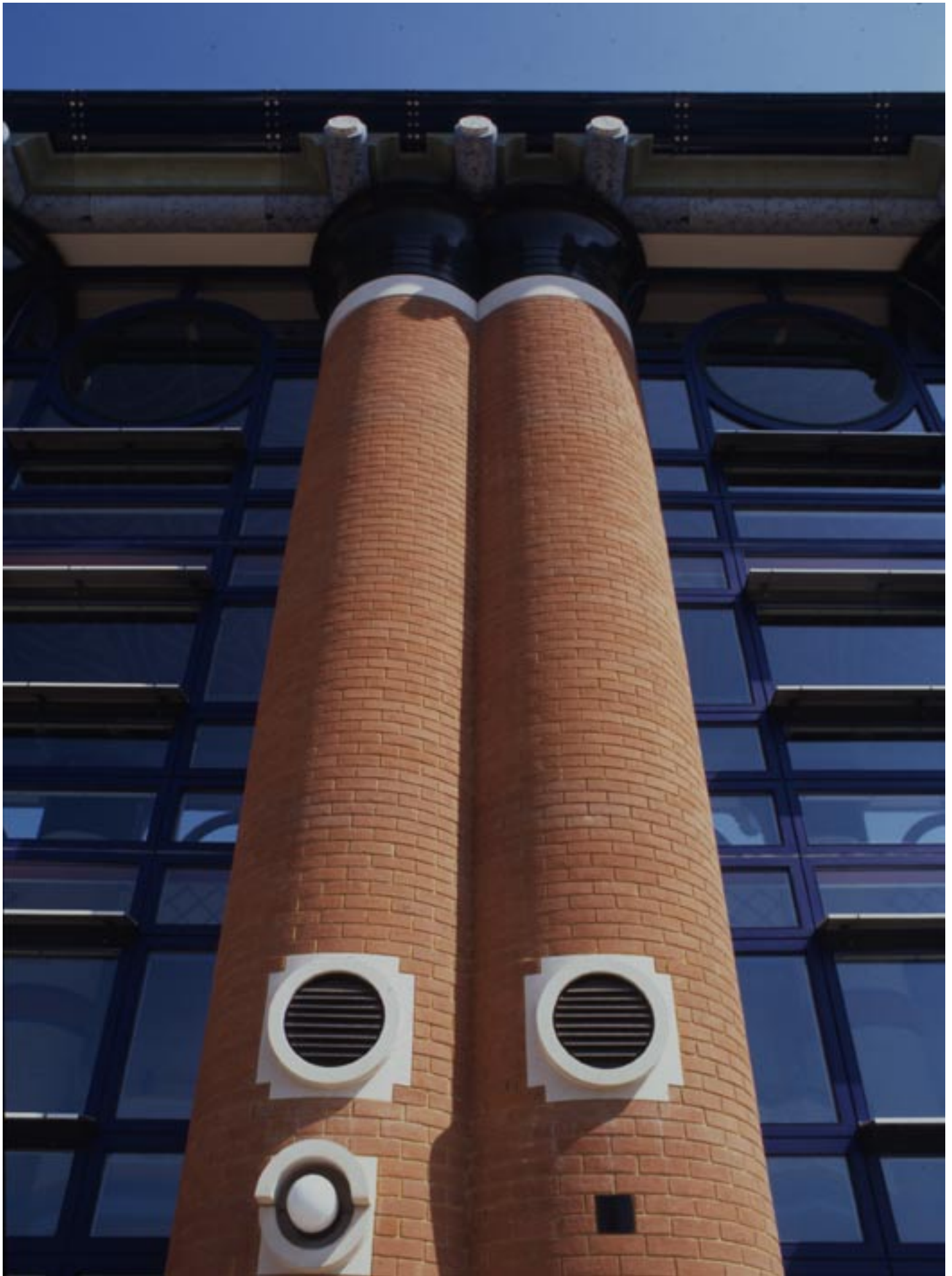

The 'half-world' of mechanics is signified as existing, within the shafts of the hypostylar forest of infinite time, by these apertures through which pass air (the big holes with louvres) light, the white 'pill', and overflow drainage (the black square). All are cast to a curved face, in brick-module sizes, and built-in as the column-wall rises. Nothing could be technically simpler. Are these things 'techno-pustules' or an amusingly gentle reminder of the 'World of Work'?

The 'body-beautiful' of the **hypostylar Gallery** shows at its best on the outside where its bare brick shafts rise with a splendid disregard for the 'heritage' of Puginian pseudo-Gothic that the 19C Establishment, terrified of Reason, Revolution and Republican Classicism, made into Britain's Neo-Feudal State Style.

The Judge's most original columns are almost certainly those that I christened the 'double-bubbles' after the double-decker fuselage of the Boeing Stratocruiser, a civilian progeny of the Superfortresses of WW2, that used to cross the Atlantic in the 1950's. The passengers had whole beds and individual cabins to while away the ten hours that the radial Pratt and Whitney engines took to pull the two-storey flying hotel between Shannon and Gander. With the 6th Order, however, the geometry of the intersection between the column-shafts would be governed by the Module of the 'canonic' logs of the rafted Entablature.

It has never been my ambition to deny the 'truth' of the 'experimentally-procured' pseudo-world of Science and Technology. I only require it to be subservient, via the use of such as the Sixth Order, to a lifespan which uses scripted space and scripted surface to mediate an understanding that discourses upon reality as it is totalised by a literacy which must, by definition, be iconic.

I therefore much regret that the columns of the 'occluded temple' of the Gallery were not inscribed with the iconography that I used for the Ark.

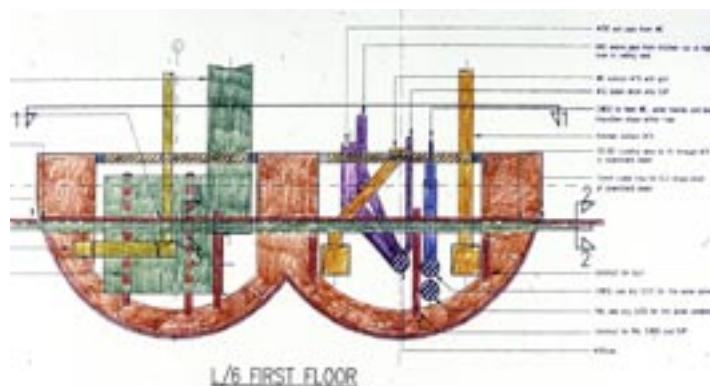
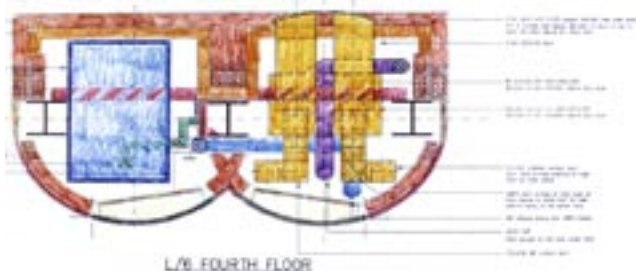

I discovered a simple truth: machines had a shorter life than buildings. Their replacements had to be manoeuvred through doors designed to admit humans. Hey-presto, build human-sized duct-doors!

The columns to the left were accessed from the curved side and the one's above from the cubic side. Colour, here, is used to inform, not to 'inspire' and confuse. Why should 'Art' be any different?



The white shoulders mediate a cubic column-base into its circular shaft. The shape was invented, in 1987, for the City of London project described on page 29. The Judge was the first time (in 1992), that we were able to build it before it finally met its complete fulfilment in the 'Walk-in(g) Order version of the Sixth Order, in the USA, in 1994. It is obvious that this composition is strongly-flavoured by Pop-Art, the only vital Art of the late 20C.

With 'double-bubble' ducts like these it is obvious why the Serving Order never, in the 30 years and the three continents of its use, never had a hernia. The exterior is insulated.

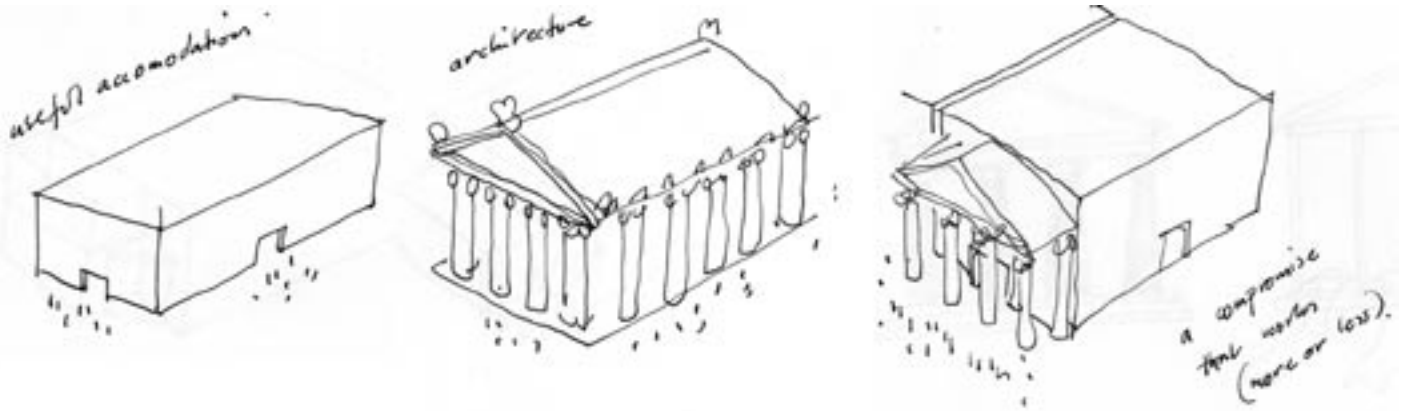

This was the situation prior to the advent of the Sixth Order. Useful accommodation (in a boxy-building) and Architecture of the 'genuine' stone-cut temple sort, lived in different worlds. This became especially noticeable as the 19C assimilated new constructive technologies and mechanical services (see Lects 01 & 02, pp 01-16 & 17 and 02-2).

Previous 'Orders', during the 19C advent of modern construction and servicing, badged the exterior with a 'temple-portico' whose architectural culture never penetrated the main interior.

The 'Sixth Order' is the first, in Modern times, to penetrate the whole body of a mundane building with an Architecture as powerful as those of the past.

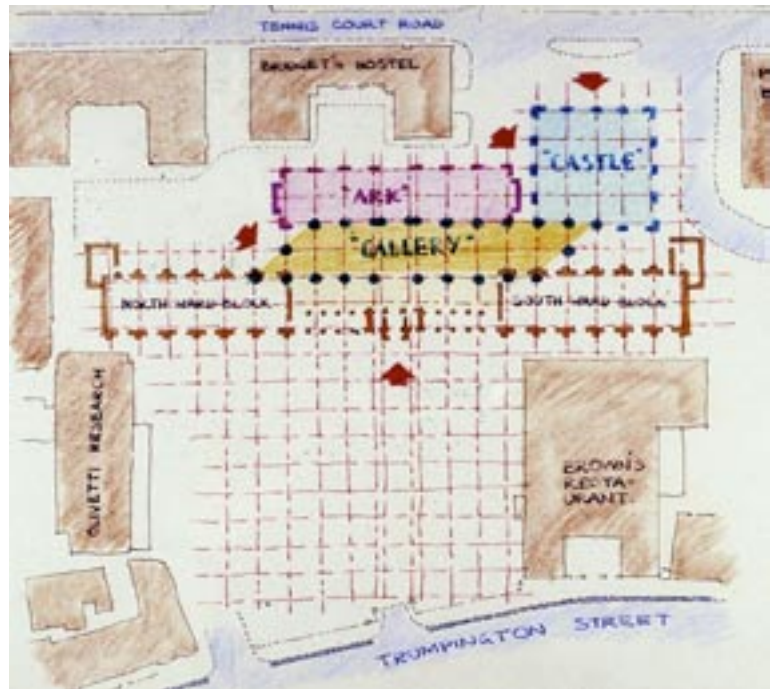

Only the Sixth Order could have extended a hugely solid, (1.5M (5'0")) diameter), 19C brick pier module into the late 20C and retained their ample, humanising, corporality. Only the Sixth Order can so bind the new to the old as to abolish the division of architecture into the new-modern and the old-heritage. Neither radical change nor real conservation can be effected without as close an integration of the 'two cultures' as is technically possible.

The 'resistance to Architecture' of 19C building construction, was challenged by the steel and glass architecture of Mies. But the hypostylar matrix which Mies van der Rohe described as "the 'divined' measure of a project" could, for the whole of orthodox 20C Modernism, only penetrate the cubic body of a building if its columns and beams were reduced to the cindered black skeletons of Rohe. The truth of Mies was that "Less was never enough!".



View into a 1:50 model of the Judge Gallery from the eighth floor. The 'Gallery' is the space opened by the 'columna lucis' in the body of the 'Mountain'. Up to two hundred can 'sit-out' in the Hypostylar Forest of this interior and network. It is a 'Camera' - but lacks a 'Lucida'.

The Sixth Order goes through cubicular compartments like a ghost through walls, leaving the ever-present epiphany of an Architectural Order that is as corporeally ample as any in history. The effect of this 'monumentalisation' of the entire body of the lifespace is to subscribe the whole building to the spatial and visual narratives of the Architectural medium at its most powerful. This is the 'corpo trasparente'!



Two paradigms shaped the Ground floor ceilings. One was to reverse the curves of arches, whose module did not fit the central bay. The other was to 'sail' the boat-shaped prows of the seminar-balconies out upon the 'sea of reality'. The expensive physiology was built. The far cheaper inscription of the 'sea-pattern' of the Gallery floor was deliberately erased. It is easier for the Professional Manager to attain his self-referentially abstracted ambitions within the deracinated 'terra nullius' of the typically blanked-out, aniconic, 'office environment'.



The 'Seminar-balconies hang out into the void of the Gallery with the central common-room beyond. People can see each other from the social stair. The big 'Serving-Columns work as screens that supply services.



The 19 'seminar-balconies' sail out into the iconic 'rain-forest' of the Gallery. They look-out over the Ark Roof-garden. With both fixed and moveable furniture, they can be flexibly configured.

"Openworking" is used by 'theory-firms'.

Theories can be exchanged.

They exist in public.

Knowledge, however, as a complex whole, exists only within each individual.

Knowledge is built by exercising theories in a context. This 'work' should oscillate between private and public. Openworking in the 'street' allows the public side of 'working a theory' to be shared by passers-by and overseen by the MD.

Openworking territories should be inscribed as public places that can not be permanently colonised by individuals. But, firstly, what surfaces are available for inscribing, and secondly, what could one 'write on such surfaces - in a business school?

JOA put forward a proposal as to how to inscribe these 'open-to-reality' surfaces.

The ambition of the Sixth Order is to be used as a tool to drastically reduce the gulf between the 'two cultures'. Management, being essentially the relation of people to their work should have the same ambition. The Judge Institute interior is designed so that the Gallery can be inscribed, on its walls, columns, ceilings and floors with scripts that discourse on the subjects that constitute 'reality'. The Seminar boxes are then used to contain groups who not only air their ideas to the citizens of the Institute, but do so in the wider context of the 'real world.

AFTERWORD for the NINETEENTH LECTURE: 'ORDINE ROBOTICO'.

The Judge Institute was the first large building that JOA had, in the fifteen years since its reluctant foundation, been given to design and build. But these years of modest achievements proved a useful apprenticeship. The assimilation of Victorian Monumentality to late-20C Welfare Squalor had foxed, in the case of this huge hospital, every other Architect who had essayed it - even indeed of the quality of my friends the wily and ingenious Hugh Casson and Neville Conder. JOA's decades of steady progress 'inwards' from the "armpits of the Industrial Estate" found us possessed of everything we needed for an alchemy which the Journal of the Society of Architectural Conservation judged: "rare it was for an unashamedly Modern addition to fit so well with an old structure". What better proof of my Profession's proudly brutal 'Modernist' incompetence!

The Business School project represented the complete 'flowering' of the Sixth Order. Indeed it was in Professor Bob Maxwell's critique of this project that its name was coined, along with his judgment that its invention constituted the "breaking of the taboos of Modernism" and "an Act of Architectural Terrorism". Yet who could possibly be so beset, upon meeting my Business School, by such awful terrors except a clever and sophisticated Critic who had given his entire credulity to all the failures of 20C lifespace-design revealed in these Lectures under the rubric of a 'breakthrough' to a New World of L'Architecture Autre?

And so it was that these modest and ingenious adaptations of the ancient devices of the Architectural 'Order' to a contemporary utility were all fiercely rejected by my own Profession. Every jury of Architects who considered the Cambridge Business School, by far the most prominent 1990's project in that city of radical Modernist constructions, refused to award it any worthy prize - even denying it one for its merely material brick and concrete innovations! It was left to the City of Cambridge itself, and the Brick Industry themselves, to mark the appreciation of those outside the blinkered horizon of 'Architecture'. JOA had transgressed a Modernist Morality taboo - but what was this imperative? That one should live in the squalor of exurbia's parking-lots?

We, in JOA, were unconcerned. We had never depended upon our own Profession for those recommendations which lead to commissions. Our ambitions remained intact. We had, at last, a wonderfully flexible 'Ordine' that could solve whatever entirely novel 'problem' we asked it to address - like providing crawlways, both vertical and horizontal, from which to service all the excellent machines that could be secreted within its robotically ample limbs. I even posted an Allen Key to the Duke of Edinburgh in case his technical curiosity (which one hears is considerable), overcame him during the people-power tedium of the opening of the building by HRH the Queen. I thought he might like to pop-open a duct door and look inside. Only later was I told that "Such things are not done"... Sad really.

